

Data Sheet



Article number: 0125108

Description: Retaining ring SP120
Spring steel

Measures

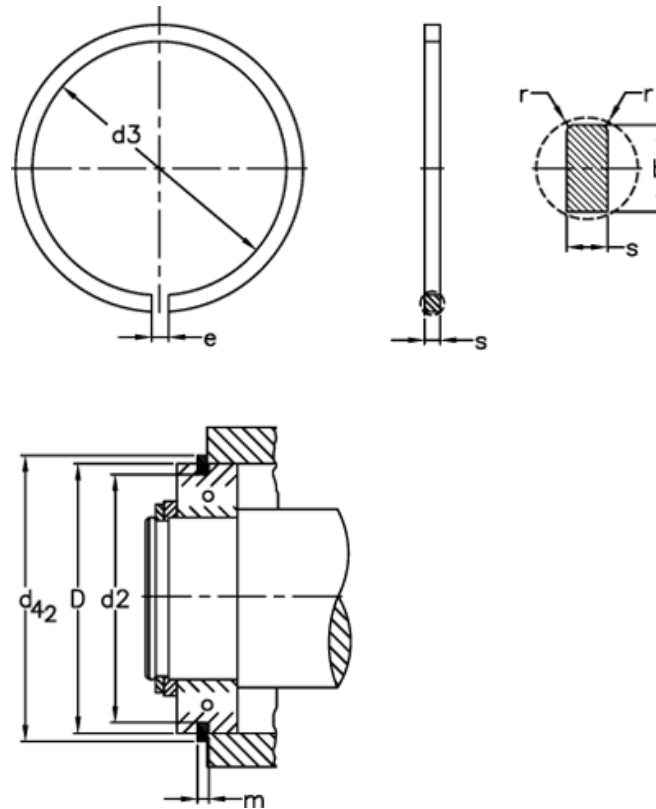

b	= 7.21	FRg kN	= 21.30	tol	= -0.15
D	= 120	FR kN	= 140.0	tol	= -0.1
d2	= 115.21	g	= 3.5	tol	= -0.50
d3	= 113.6	K kN-mm	= 291.0	tol	= 0.3
d42	= 129.7	m	= 3.10	tol	= 1.0
Description	= SP 120	n abl x 1000	= 2.0	Weight kg/1000	= 60.6
e	= 7	r min	= 0.7		
FN kN	= 143.0	s	= 2.82		